

S Compression Fittings

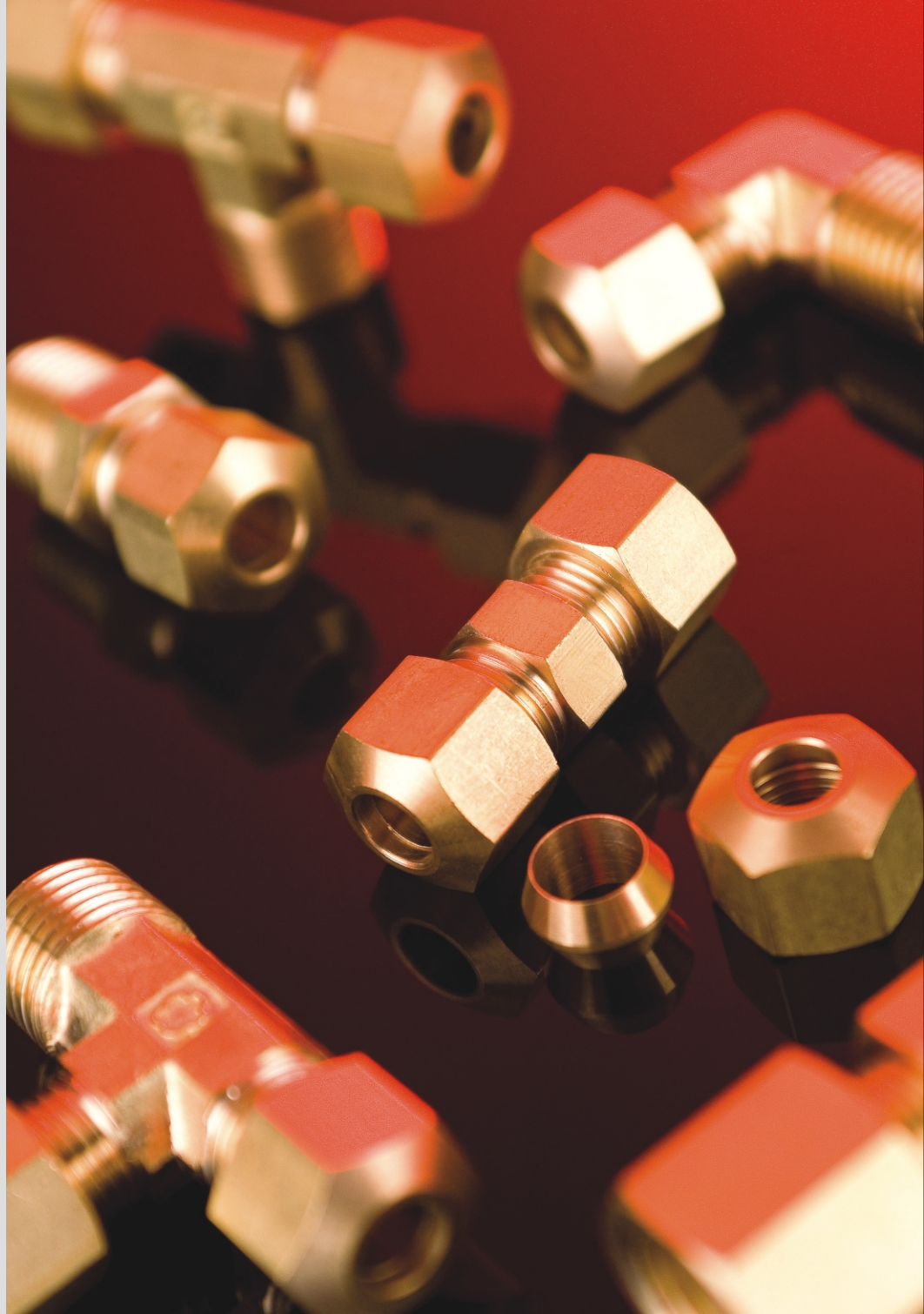

S series
Compression Fittings
銅珠套管系列

S Compression Fittings 銅珠套管系列

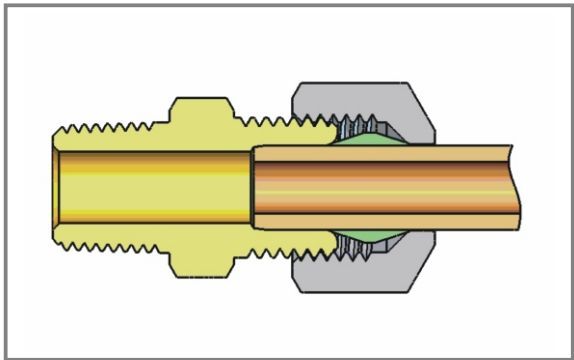
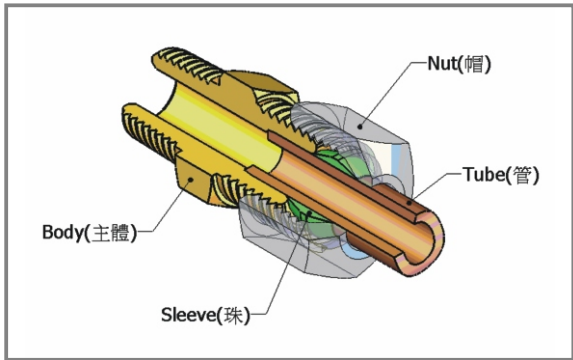

特點

應用於液態流體或氣體之傳遞。
 不需擴孔, 焊接或做任何管子上的處理, 且容易組裝。
 用於紅銅, 黃銅, 鋁等金屬管, 不可用於鋼管。
 配合支撐插套則可使用於熱塑管 (或可參考NF系列產品)。
 此類接件是依據SAE-J512為參考標準而設計。

材質

接頭、銅珠、螺帽均採用黃銅JIS3604材質加工而成。
 彎頭、三通均採用黃銅JIS3771材質鍛造並加工而成。

工作溫度

金屬管使用於-54°C~ +121°C
 熱塑管則根據可使用之溫度而定。

工作壓力

使用金屬管
 100~140 Bar
 在室溫20°C的情況下使用熱塑管
 O.D. 1/8" 28Bar
 O.D. 1/4" 20Bar
 O.D. 3/8" 14Bar
 O.D. 1/2" 14Bar
 O.D. 5/8" 10Bar
 O.D. 3/4" 7Bar
 O.D. 7/8" 5Bar

組裝步驟

1. 正交的剪切管到所需長度, 並清除去管子毛邊。
2. 依序將螺帽與銅珠穿過管, 螺帽螺紋端要朝外側。
3. 將管子放入接件中, 確定碰觸到接件內孔底端。
4. 先用手旋緊螺帽與主體。
5. 再用扳手順時鐘旋緊數圈, 旋緊圈數請依據下列表中數據進行。

Characteristic

Use for liquids or air. No flaring, soldering or other preparation of tubing necessary to assemble.
 Use with copper, brass, aluminum and thermoplastic tubing.
 No recommended for steel tubing.

Material

Connectors, nuts, sleeves are machined from brass JIS3604
 Elbows, tees are forged and machined from brass JIS3771

Working Temperature

From -65°F~250°F with soft metal tubing.
 For thermoplastic tubing, see manufacturers recommendation.

Working Pressure

With soft metal tubing
 1500PSI~2000PSI
 With thermoplastic tubing under 68° F temperature
 O.D. 1/8" 400PSI
 O.D. 1/4" 300PSI
 O.D. 3/8" 200PSI
 O.D. 1/2" 200PSI
 O.D. 5/8" 150PSI
 O.D. 3/4" 100PSI
 O.D. 7/8" 75PSI

Assembly Instruction

1. Cut tubing squarely and clean tube end to remove burrs.
2. Slide nut and sleeve onto tubing, place threaded end of nut face out.
3. Insert the tube into the fitting. Be sure the tube is bottomed on the fitting shoulder.
4. Assemble nut to body, and tighten "hand-tight".
5. Then follow the number of wrench turns as indicated in the following table.

管徑 TubeSize		需要圈數 Turns required from hand-tight	
Inch	metric	軟金屬管 With soft metal tubing	熱塑管 With thermoplastic tubing
1/8"	4mm	1.5~2.5	-
3/16"	5mm	1.5~2.5	-
1/4"	6mm	1.5~2.5	2.5
5/16"	8mm	1.5~2.5	2.5
3/8"	10mm	2~3	3
1/2"	12mm	2~3	3
5/8"	15mm	2~3	3
3/4"	-	2~3	3
7/8"	-	2~3	-

Adapter

S00
公制螺帽
Metric Nut

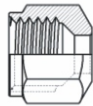

Page S 3

S00
英制螺帽
Inch Nut

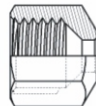

Page S 3

S01
銅珠
Sleeve

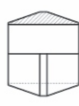

Page S 3

S12
油塞
Plug

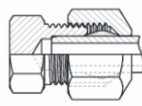

Page S 14

S02
由任接頭
Union

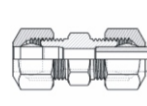

Page S 4

S02
減壓由任接頭
Union reducer

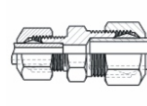

Page S 4

S11
夾壁式由任接頭
Bulkhead
Union

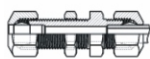

Page S 14

S05
外牙接頭
Male
Connector

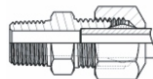

Page S 6-S 7

S06
內牙接頭
Female
Connector

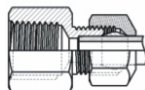

Page S 8

Elbow

S03
由任彎頭
Union Elbow

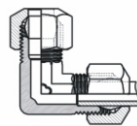

Page S 5

S07
外牙彎頭
Male Elbow

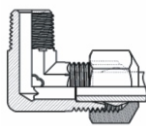

Page S 9-S 10

S13
45° 外牙彎頭
45° Male Elbow

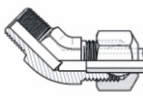

Page S 15

S08
內牙彎頭
Female Elbow

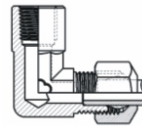

Page S 11

Tee

S04
由任三通
Union Tee

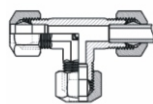

Page S 5

S09
牙中三通
Branch Tee

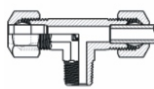

Page S 12

S10
牙邊三通
Run Tee

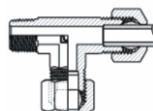

Page S 13

A/E
Pipe Fittings

A/E
Hose Barb

H
45° Flared

S
Compression

S/B
Bite Type

N
Fast-In Fittings

N/F
Ferrule Quick

P
Push-In Fittings

V
Valves

S00

螺帽 Nut

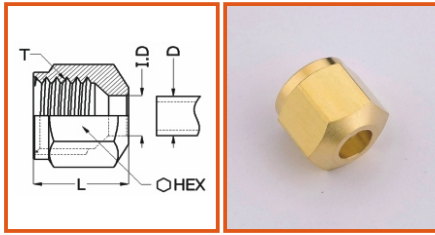

產品編號	適用管徑 D	直牙 T	L	HEX	I.D
PART NO.	TubeSize D	Thread T			
S00-04	4	M8×1.0	9.3	9.5	4.3
S00-05	5	M10×1.0	10	12	5.3
S00-2	6	M11×1.0	11	14	6.7
S00-25	8	1/2-24	12	16	8.3
S00-10	10	9/16-24	12.5	17	10.3
S00-12	12	11/16-20	14	21	12.3
S00-M15	15	13/16-18	15	24	15.3

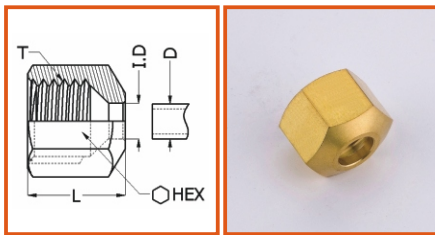

產品編號	適用管徑 D	直牙 T	L	HEX	I.D
PART NO.	TubeSize D	Thread T			
S00-1	1/8	M8×1.0	9.3	9.5	3.5
S00-05	3/16	M10×1.0	10	12	5.3
S00-2	1/4	M11×1.0	11	14	6.7
S00-25	5/16	1/2-24	12	16	8.3
S00-3	3/8	9/16-24	12.5	17	9.9
S00-4	1/2	11/16-20	14	21	13
S00-5	5/8	13/16-18	15	24	16.2
S00-6	3/4	1"-18	16.5	30	19.4
S00-7	7/8	1 1/8"-18	17	32	22.5

S01

銅珠 Sleeve

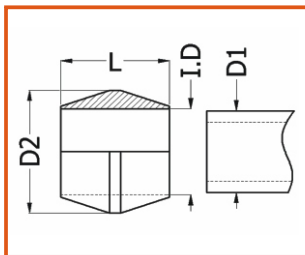

產品編號	適用管徑 D1	L	D2	I.D
PART NO.	TubeSize D1			
S01-04	4	5	6	4.2
S01-05	5	6	7	5.2
S01-06	6	6	8.5	6.2
S01-10	10	8	12.5	10.2
S01-12	12	8.5	15	12.2
S01-M15	15	8	18	15.2

產品編號	適用管徑 D1	L	D2	I.D
PART NO.	TubeSize D1			
S01-1	1/8	5	5.5	3.3
S01-15	3/16	6	7	4.9
S01-2	1/4	6	8.5	6.5
S01-25	5/16	7	11	8.2
S01-3	3/8	8	12.5	9.7
S01-4	1/2	8.5	15.9	12.9
S01-5	5/8	8	19	16.1
S01-6	3/4	8.5	22	19.3
S01-7	7/8	9	25.4	22.4

S02

由任接頭 Union

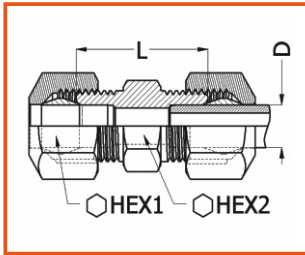

產品編號	適用管徑 D	直牙	L	HEX1	HEX2
PART NO.	TubeSize D	Thread			
S02-C05	5	M10×1.0	21	12	12
S02-C06	6	M11×1.0	22	14	12
S02-C25	8	1/2-24	23	16	14
S02-C10	10	9/16-24	24	17	15
S02-C12	12	11/16-20	26	21	19
S02-CM15	15	13/16-18	29	24	21

產品編號	適用管徑 D	直牙	L	HEX1	HEX2
PART NO.	TubeSize D	Thread			
S02-C1	1/8	M8×1.0	20	9.5	12
S02-C15	3/16	M10×1.0	21	12	12
S02-C2	1/4	M11×1.0	22	14	12
S02-C25	5/16	1/2-24	23	16	14
S02-C3	3/8	9/16-24	24	17	15
S02-C4	1/2	11/16-20	26	21	19
S02-C5	5/8	13/16-18	29	24	21
S02-C6	3/4	1"-18	31	30	26
S02-C7	7/8	1 1/8"-18	32	32	30

S02

減壓由任接頭 Union Reducer

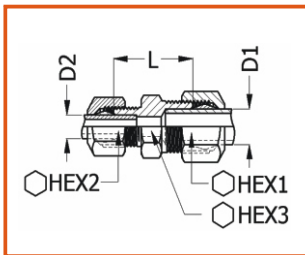

產品編號	適用管徑 D1	D1 直牙	適用管徑 D2	D2 直牙	L	HEX1	HEX2	HEX3
PART NO.	TubeSize D1	D1 Thread	TubeSize D2	D2 Thread				
S02-C06010	10	9/16-24	6	M11×1.0	23	17	14	15
S02-C10012	12	11/16-20	10	9/16-24	25.5	21	17	19

產品編號	適用管徑 D1	D1 直牙	適用管徑 D2	D2 直牙	L	HEX1	HEX2	HEX3
PART NO.	TubeSize D1	D1 Thread	TubeSize D2	D2 Thread				
S02-C203	3/8	9/16-24	1/4	M11×1.0	23	17	14	15
S02-C304	1/2	11/16-20	3/8	9/16-24	25.5	21	17	19
S02-C305	5/8	13/16-18	3/8	9/16-24	27	24	17	21

A/E Pipe Fittings

A/E Hose Barb

H 45° Flared

S Compression

S/B Bite Type

N Fast-In Fittings

N/F Ferrule Quick

P Push-In Fittings

V Valves

S03

由任彎頭 Union Elbow

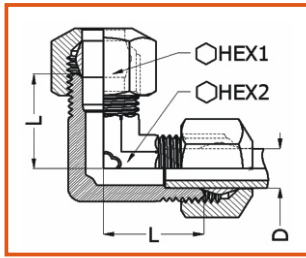

產品編號	適用管徑 D	直牙	L	HEX1	HEX2
PART NO.	TubeSize D	Thread			
S03-L05	5	M10×1.0	15.5	12	9.5
S03-L06	6	M11×1.0	16.5	14	9.5
S03-L25	8	1/2-24	19.2	16	11
S03-L10	10	9/16-24	21	17	13
S03-L12	12	11/16-20	23	21	13
S03-LM15	15	13/16-18	26	24	17

產品編號	適用管徑 D	直牙	L	HEX1	HEX2
PART NO.	TubeSize D	Thread			
S03-L1	1/8	M8×1.0	15	9.5	9.5
S03-L15	3/16	M10×1.0	15.5	12	9.5
S03-L2	1/4	M11×1.0	16.5	14	9.5
S03-L25	5/16	1/2-24	19.2	16	11
S03-L3	3/8	9/16-24	21	17	13
S03-L4	1/2	11/16-20	23	21	13
S03-L5	5/8	13/16-18	26	24	17
S03-L6	3/4	1"-18	27.9	30	21

S04

由任三通 Union Tee

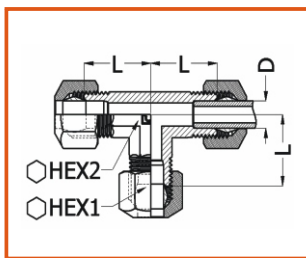

產品編號	適用管徑 D	直牙	L	HEX1	HEX2
PART NO.	TubeSize D	Thread			
S04-T05	5	M10×1.0	16.5	12	9.5
S04-T06	6	M11×1.0	18	14	9.5
S04-T25	8	1/2-24	18.5	16	11
S04-T10	10	9/16-24	21	17	12
S04-T12	12	11/16-20	25	21	15

產品編號	適用管徑 D	直牙	L	HEX1	HEX2
PART NO.	TubeSize D	Thread			
S04-T1	1/8	M8×1.0	15.5	9.5	9.5
S04-T15	3/16	M10×1.0	16.5	12	9.5
S04-T2	1/4	M11×1.0	18	14	9.5
S04-T25	5/16	1/2-24	18.5	16	11
S04-T3	3/8	9/16-24	21	17	12
S04-T4	1/2	11/16-20	25	21	15
S04-T5	5/8	13/16-18	28	24	17

S05

外牙接頭 Male Connector

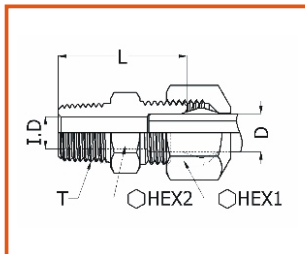

產品編號	適用管徑 D	管牙 T	直牙	I.D	L	HEX1	HEX2
PART NO.	TubeSize D	PipeThread T	Thread				
S05-C1004	4	1/8	M8×1.0	3.5	21	9.5	12
S05-C1005	5	1/8	M10×1.0	4	21.5	12	12
S05-C1006	6	1/8	M11×1.0	5.5	22	14	12
S05-C1025	8	1/8	1/2-24	5.5	22.5	16	14
S05-C1010	10	1/8	9/16-24	5.5	23	17	15
S05-C2004	4	1/4	M8×1.0	3.5	24	9.5	14
S05-C2005	5	1/4	M10×1.0	4	24.5	12	14
S05-C2006	6	1/4	M11×1.0	5.5	25	14	14
S05-C2025	8	1/4	1/2-24	7	25.5	16	14
S05-C2010	10	1/4	9/16-24	8	26	17	15
S05-C2012	12	1/4	11/16-20	8	27.5	21	19
S05-C3006	6	3/8	M11×1.0	5.5	25	14	17
S05-C3025	8	3/8	1/2-24	7	25.5	16	17
S05-C3010	10	3/8	9/16-24	8	26	17	17
S05-C3012	12	3/8	11/16-20	10.5	27.5	21	19
S05-C30M15	15	3/8	13/16-18	10.5	29.5	24	21
S05-C4006	6	1/2	M11×1.0	5.5	28.5	14	21
S05-C4025	8	1/2	1/2-24	7	29	16	21
S05-C4010	10	1/2	9/16-24	8	29.5	17	21
S05-C4012	12	1/2	11/16-20	11	30	21	21
S05-C40M15	15	1/2	13/16-18	14	32	24	21

A/E
Pipe Fittings

A/E
Hose Barb

H
45° Flared

S
Compression

S/B
Bite Type

N
Fast-In Fittings

N/F
Ferrule Quick

P
Push-In Fittings

V
Valves

S05

外牙接頭 Male Connector

產品編號	適用管徑 D	管牙 T	直牙	I.D	L	HEX1	HEX2
PART NO.	TubeSize D	PipeThread T	Thread				
S05-C101	1/8	1/8	M8×1.0	3	21	9.5	12
S05-C1015	3/16	1/8	M10×1.0	4	21.5	12	12
S05-C102	1/4	1/8	M11×1.0	5.5	22	14	12
S05-C1025	5/16	1/8	1/2-24	5.5	22.5	16	14
S05-C103	3/8	1/8	9/16-24	5.5	23	17	15
S05-C201	1/8	1/4	M8×1.0	3	24	9.5	14
S05-C2015	3/16	1/4	M10×1.0	4	24.5	12	14
S05-C202	1/4	1/4	M11×1.0	5.5	25	14	14
S05-C2025	5/16	1/4	1/2-24	7	25.5	16	14
S05-C203	3/8	1/4	9/16-24	8	26	17	15
S05-C204	1/2	1/4	11/16-20	8	27.5	21	19
S05-C302	1/4	3/8	M11×1.0	5.5	25	14	17
S05-C3025	5/16	3/8	1/2-24	7	25.5	16	17
S05-C303	3/8	3/8	9/16-24	8	26	17	17
S05-C304	1/2	3/8	11/16-20	10.5	27.5	21	19
S05-C305	5/8	3/8	13/16-18	10.5	29.5	24	21
S05-C402	1/4	1/2	M11×1.0	5.5	28.5	14	21
S05-C4025	5/16	1/2	1/2-24	7	29	16	21
S05-C403	3/8	1/2	9/16-24	8	29.5	17	21
S05-C404	1/2	1/2	11/16-20	11	30	21	21
S05-C405	5/8	1/2	13/16-18	14	32	24	21
S05-C603	3/8	3/4	9/16-24	8	31	17	27
S05-C604	1/2	3/4	11/16-20	11	31.5	21	27
S05-C605	5/8	3/4	13/16-18	14	33.5	24	27
S05-C606	3/4	3/4	1"-18	16	34.5	30	27

A/E
Pipe Fittings

A/E
Hose Barb

H
45° Flared

S
Compression

S/B
Bite Type

N
Fast-In Fittings

N/F
Ferrule Quick

P
Push-In Fittings

V
Valves

S06

內牙接頭 Female Connector

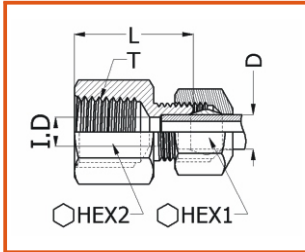

產品編號 PART NO.	適用管徑 D TubeSize D	內管牙 T PipeThread T	直牙 Thread	I.D.	L	HEX1	HEX2
S06-CM1004	4	1/8	M8×1.0	3.5	19	9.5	12
S06-CM1005	5	1/8	M10×1.0	4	19.5	12	12
S06-CM1006	6	1/8	M11×1.0	5.5	20	14	12
S06-CM1025	8	1/8	1/2-24	7	20	16	12.7
S06-CM1010	10	1/8	9/16-24	8	20	17	15
S06-CM2005	5	1/4	M10×1.0	4	22.5	12	17
S06-CM2006	6	1/4	M11×1.0	5.5	23	14	17
S06-CM2025	8	1/4	1/2-24	7	23.5	16	17
S06-CM2010	10	1/4	9/16-24	8	24	17	17
S06-CM2012	12	1/4	11/16-20	11.4	22.5	21	19
S06-CM3006	6	3/8	M11×1.0	5.5	23	14	21
S06-CM3025	8	3/8	1/2-24	7	23.5	16	21
S06-CM3010	10	3/8	9/16-24	8	24	17	21
S06-CM3012	12	3/8	11/16-20	11	24.5	21	21
S06-CM4006	6	1/2	M11×1.0	5.5	26	14	24
S06-CM4025	8	1/2	1/2-24	7	26.5	16	24
S06-CM4010	10	1/2	9/16-24	8	27	17	24
S06-CM4012	12	1/2	11/16-20	11	27.5	21	24
S06-CM40M15	15	1/2	13/16-18	14	29.5	24	24

產品編號 PART NO.	適用管徑 D TubeSizeD	內管牙 T PipeThread T	直牙 Thread	I.D.	L	HEX1	HEX2
S06-CM101	1/8	1/8	M8×1.0	3	19	9.5	12
S06-CM1015	3/16	1/8	M10×1.0	4	19.5	12	12
S06-CM102	1/4	1/8	M11×1.0	5.5	20	14	12
S06-CM1025	5/16	1/8	1/2-24	7	20	16	12.7
S06-CM103	3/8	1/8	9/16-24	8	20	17	15
S06-CM2015	3/16	1/4	M10×1.0	4	22.5	12	17
S06-CM202	1/4	1/4	M11×1.0	5.5	23	14	17
S06-CM2025	5/16	1/4	1/2-24	7	23.5	16	17
S06-CM203	3/8	1/4	9/16-24	8	24	17	17
S06-CM204	1/2	1/4	11/16-20	11.4	22.5	21	19
S06-CM302	1/4	3/8	M11×1.0	5.5	23	14	21
S06-CM3025	5/16	3/8	1/2-24	7	23.5	16	21
S06-CM303	3/8	3/8	9/16-24	8	24	17	21
S06-CM304	1/2	3/8	11/16-20	11	24.5	21	21
S06-CM305	5/8	3/8	13/16-18	14	25.5	24	21
S06-CM402	1/4	1/2	M11×1.0	5.5	26	14	24
S06-CM4025	5/16	1/2	1/2-24	7	26.5	16	24
S06-CM403	3/8	1/2	9/16-24	8	27	17	24
S06-CM404	1/2	1/2	11/16-20	11	27.5	21	24
S06-CM405	5/8	1/2	13/16-18	14	29.5	24	24

A/E Pipe Fittings

A/E Hose Barb

H 45° Flared

S Compression

SB Bite Type

N Fast-In Fittings

NF Ferrule Quick

P Push-In Fittings

V Valves

S07

外牙彎頭 Male Elbow

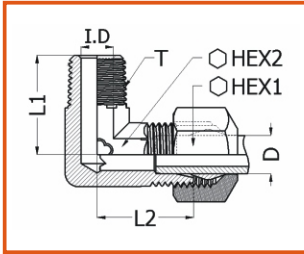

產品編號	適用管徑 D	管牙 T	直牙	I.D	L1	L2	HEX1	HEX2
PART NO.	TubeSize D	PipeThread T	Thread					
S07-L1004	4	1/8	M8×1.0	3.5	17	15	9.5	9.5
S07-L1005	5	1/8	M10×1.0	4	17	15.5	12	9.5
S07-L1006	6	1/8	M11×1.0	5.5	17	16.5	14	9.5
S07-L1025	8	1/8	1/2-24	5.5	18.4	18.4	16	10.5
S07-L1010	10	1/8	9/16-24	5.5	20	21	17	13
S07-L2004	4	1/4	M8×1.0	3.5	22.2	17.1	9.5	11
S07-L2005	5	1/4	M10×1.0	4	22.2	17.1	12	11
S07-L2006	6	1/4	M11×1.0	5.5	22.2	18.1	14	11
S07-L2025	8	1/4	1/2-24	7	23.2	18.7	16	11
S07-L2010	10	1/4	9/16-24	8	23	21	17	13
S07-L2012	12	1/4	11/16-20	8	23	23	21	13
S07-L3006	6	3/8	M11×1.0	5.5	23.2	18.7	14	11
S07-L3025	8	3/8	1/2-24	7	23.2	19.2	16	11
S07-L3010	10	3/8	9/16-24	8	24	21	17	13
S07-L3012	12	3/8	11/16-20	9	24	23	21	13
S07-L30M15	15	3/8	13/16-18	10.5	26.8	25.8	24	15
S07-L4006	6	1/2	M11×1.0	5.5	29.3	22.3	14	15
S07-L4025	8	1/2	1/2-24	7	29.3	22.8	16	15
S07-L4010	10	1/2	9/16-24	8	28.8	22.3	17	15
S07-L4012	12	1/2	11/16-20	11	29.3	25.3	21	15
S07-L40M15	15	1/2	13/16-18	13	29.7	26.2	24	17

A/E
Pipe Fittings

A/E
Hose Barb

H
45° Flared

S
Compression

S/B
Bite Type

N
Fast-In Fittings

N/F
Ferrule Quick

P
Push-In Fittings

V
Valves

S07

外牙彎頭 Male Elbow

產品編號	適用管徑 D	管牙 T	直牙	I.D	L1	L2	HEX1	HEX2
PART NO.	TubeSize D	PipeThread T	Thread					
S07-L101	1/8	1/8	M8×1.0	3	17	15	9.5	9.5
S07-L1015	3/16	1/8	M10×1.0	4	17	15.5	12	9.5
S07-L102	1/4	1/8	M11×1.0	5.5	17	16.5	14	9.5
S07-L1025	5/16	1/8	1/2-24	5.5	18.4	18.4	16	10.5
S07-L103	3/8	1/8	9/16-24	5.5	20	21	17	13
S07-L201	1/8	1/4	M8×1.0	3	22.2	17.1	9.5	11
S07-L2015	3/16	1/4	M10×1.0	4	22.2	17.1	12	11
S07-L202	1/4	1/4	M11×1.0	5.5	22.2	18.1	14	11
S07-L2025	5/16	1/4	1/2-24	7	23.2	18.7	16	11
S07-L203	3/8	1/4	9/16-24	8	23	21	17	13
S07-L204	1/2	1/4	11/16-20	8	23	23	21	13
S07-L302	1/4	3/8	M11×1.0	5.5	23.2	18.7	14	11
S07-L3025	5/16	3/8	1/2-24	7	23.2	19.2	16	11
S07-L303	3/8	3/8	9/16-24	8	24	21	17	13
S07-L304	1/2	3/8	11/16-20	9	24	23	21	13
S07-L305	5/8	3/8	13/16-18	10.5	26.8	25.8	24	15
S07-L402	1/4	1/2	M11×1.0	5.5	29.3	22.3	14	15
S07-L4025	5/16	1/2	1/2-24	7	29.3	22.8	16	15
S07-L403	3/8	1/2	9/16-24	8	29.3	23.3	17	15
S07-L404	1/2	1/2	11/16-20	11	29.3	25.3	21	15
S07-L405	5/8	1/2	13/16-18	13	29.7	26.2	24	17
S07-L406	3/4	1/2	1"-18	13	33.5	28.5	30	17

A/E
Pipe Fittings

A/E
Hose Barb

H
45° Flared

S
Compression

S/B
Bite Type

N
Fast-In Fittings

N/F
Ferrule Quick

P
Push-In Fittings

V
Valves

S08

內牙彎頭 Female Elbow

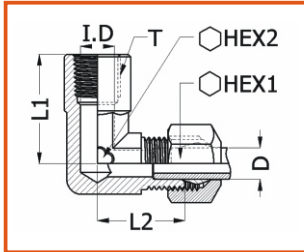

產品編號	適用管徑 D	內管牙 T	直牙	I.D	L1	L2	HEX1	HEX2
PART NO.	TubeSize D	Pipe Thread T	Thread					
S08-LM1004	4	1/8	M8×1.0	3.5	22.7	17.1	9.5	11
S08-LM1005	5	1/8	M10×1.0	4	22.7	17.1	12	11
S08-LM1006	6	1/8	M11×1.0	5.5	22.7	18.1	14	11
S08-LM1025	8	1/8	1/2-24	7	23.2	18.7	16	11
S08-LM1010	10	1/8	9/16-24	8	23.5	21	17	13
S08-LM2006	6	1/4	M11×1.0	5.5	26.1	18.7	14	11
S08-LM2025	8	1/4	1/2-24	7	26.1	19.2	16	11
S08-LM2010	10	1/4	9/16-24	8	26.5	21	17	13
S08-LM2012	12	1/4	11/16-20	9	27.5	23	21	13
S08-LM3006	6	3/8	M11×1.0	5.5	28.8	22.3	14	15
S08-LM3025	8	3/8	1/2-24	7	28.8	22.8	16	15
S08-LM3010	10	3/8	9/16-24	8	28.8	23.3	17	15
S08-LM3012	12	3/8	11/16-20	11	28.8	25.3	21	15

產品編號	適用管徑 D	內管牙 T	直牙	I.D	L1	L2	HEX1	HEX2
PART NO.	TubeSize D	Pipe Thread T	Thread					
S08-LM1015	3/16	1/8	M10×1.0	4	22.7	17.1	12	11
S08-LM102	1/4	1/8	M11×1.0	5.5	22.7	18.1	14	11
S08-LM1025	5/16	1/8	1/2-24	7	23.2	18.7	16	11
S08-LM103	3/8	1/8	9/16-24	8	23.5	21	17	13
S08-LM202	1/4	1/4	M11×1.0	5.5	26.1	18.7	14	11
S08-LM2025	5/16	1/4	1/2-24	7	26.1	19.2	16	11
S08-LM203	3/8	1/4	9/16-24	8	26.5	21	17	13
S08-LM204	1/2	1/4	11/16-20	9	27.5	22	21	13
S08-LM302	1/4	3/8	M11×1.0	5.5	28.8	22.3	14	15
S08-LM3025	5/16	3/8	1/2-24	7	28.8	22.8	16	15
S08-LM303	3/8	3/8	9/16-24	8	28.8	23.3	17	15
S08-LM304	1/2	3/8	11/16-20	11	28.8	25.3	21	15

- A/E Pipe Fittings
- A/E Hose Barb
- H 45° Flared
- S Compression
- S/B Bite Type
- N Fast-In Fittings
- N/F Ferrule Quick
- P Push-In Fittings
- V Valves

S09

牙中三通 Branch Tee

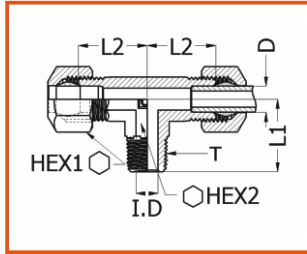

產品編號 PART NO.	適用管徑 D TubeSize D	管牙 T Pipe Thread T	直牙 Thread	I.D	L1	L2	HEX1	HEX2
S09-T1006	6	1/8	M11×1.0	5.5	18	18	14	9.5
S09-T1025	8	1/8	1/2-24	5.5	18.5	18.5	16	11
S09-T1010	10	1/8	9/16-24	5.5	20	21	17	12
S09-T2006	6	1/4	M11×1.0	5.5	21.5	18	14	11
S09-T2025	8	1/4	1/2-24	7	21.5	18.5	16	11
S09-T2010	10	1/4	9/16-24	8	23	21	17	12
S09-T2012	12	1/4	11/16-20	8	25	25	21	15
S09-T3006	6	3/8	M11×1.0	5.5	23.5	19.5	14	12
S09-T3025	8	3/8	1/2-24	7	23.5	20	16	12
S09-T3010	10	3/8	9/16-24	8	23.5	21	17	12
S09-T3012	12	3/8	11/16-20	10.5	26	25	21	15
S09-T30M15	15	3/8	13/16-18	11	25.5	26	24	17
S09-T4006	6	1/2	M11×1.0	5.5	29.4	21.5	14	15
S09-T4025	8	1/2	1/2-24	7	29.4	22	16	15
S09-T4010	10	1/2	9/16-24	8	29.4	22.5	17	15
S09-T4012	12	1/2	11/16-20	11	29.4	25	21	15
S09-T40M15	15	1/2	13/16-18	13	29.5	26	24	17

產品編號 PART NO.	適用管徑 D TubeSize D	管牙 T Pipe Thread T	直牙 Thread	I.D	L1	L2	HEX1	HEX2
S09-T102	1/4	1/8	M11×1.0	5.5	18	18	14	9.5
S09-T1025	5/16	1/8	1/2-24	5.5	18.5	18.5	16	11
S09-T103	3/8	1/8	9/16-24	5.5	20	21	17	12
S09-T202	1/4	1/4	M11×1.0	5.5	21.5	18	14	11
S09-T2025	5/16	1/4	1/2-24	7	21.5	18.5	16	11
S09-T203	3/8	1/4	9/16-24	8	23	21	17	12
S09-T204	1/2	1/4	11/16-20	8	25	25	21	15
S09-T302	1/4	3/8	M11×1.0	5.5	23.5	19.5	14	12
S09-T3025	5/16	3/8	1/2-24	7	23.5	20	16	12
S09-T303	3/8	3/8	9/16-24	8	23.5	21	17	12
S09-T304	1/2	3/8	11/16-20	10.5	26	25	21	15
S09-T305	5/8	3/8	13/16-18	11	25.5	26	24	17
S09-T402	1/4	1/2	M11×1.0	5.5	29.4	21.5	14	15
S09-T4025	5/16	1/2	1/2-24	7	29.4	22	16	15
S09-T403	3/8	1/2	9/16-24	8	29.4	22.5	17	15
S09-T404	1/2	1/2	11/16-20	11	29.4	25	21	15
S09-T405	5/8	1/2	13/16-18	13	29.5	26	24	17

A/E Pipe Fittings

A/E Hose Barb

H 45° Flared

S Compression

SB Bite Type

N Fast-In Fittings

NF Ferrule Quick

P Push-In Fittings

V Valves

S10

牙邊三通 Run Tee

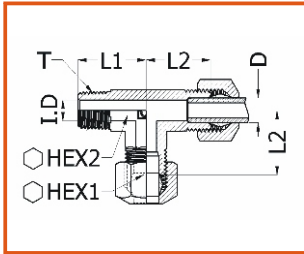

產品編號	適用管徑 D	管牙 T	直牙	ID	L1	L2	HEX1	HEX2
PART NO.	TubeSize D	Pipe Thread T	Thread					
S10-T1006	6	1/8	M11×1.0	5.5	18	18	14	9.5
S10-T1025	8	1/8	1/2-24	5.5	18.5	18.5	16	11
S10-T1010	10	1/8	9/16-24	5.5	20	21	17	12
S10-T2006	6	1/4	M11×1.0	5.5	21.5	18	14	11
S10-T2025	8	1/4	1/2-24	7	21.5	18.5	16	11
S10-T2010	10	1/4	9/16-24	8	23	21	17	12
S10-T2012	12	1/4	11/16-20	8	25	25	21	15
S10-T3006	6	3/8	M11×1.0	5.5	23.5	19.5	14	12
S10-T3025	8	3/8	1/2-24	7	23.5	20	16	12
S10-T3010	10	3/8	9/16-24	8	23.5	21	17	12
S10-T3012	12	3/8	11/16-20	10.5	26	25	21	15
S10-T30M15	15	3/8	13/16-18	11	25.5	26	24	17
S10-T4006	6	1/2	M11×1.0	5.5	29.4	21.5	14	15
S10-T4025	8	1/2	1/2-24	7	29.4	22	16	15
S10-T4010	10	1/2	9/16-24	8	29.4	22.5	17	15
S10-T4012	12	1/2	11/16-20	11	29.4	25	21	15
S10-T40M15	15	1/2	13/16-18	13	29.5	26	24	17

產品編號	適用管徑 D	管牙 T	直牙	ID	L1	L2	HEX1	HEX2
PART NO.	TubeSize D	Pipe Thread T	Thread					
S10-T102	1/4	1/8	M11×1.0	5.5	18	18	14	9.5
S10-T1025	5/16	1/8	1/2-24	5.5	18.5	18.5	16	11
S10-T103	3/8	1/8	9/16-24	5.5	20	21	17	12
S10-T202	1/4	1/4	M11×1.0	5.5	21.5	18	14	11
S10-T2025	5/16	1/4	1/2-24	7	21.5	18.5	16	11
S10-T203	3/8	1/4	9/16-24	8	23	21	17	12
S10-T204	1/2	1/4	11/16-20	8	25	25	21	15
S10-T302	1/4	3/8	M11×1.0	5.5	23.5	19.5	14	12
S10-T3025	5/16	3/8	1/2-24	7	23.5	20	16	12
S10-T303	3/8	3/8	9/16-24	8	23.5	21	17	12
S10-T304	1/2	3/8	11/16-20	10.5	26	25	21	15
S10-T305	5/8	3/8	13/16-18	11	25.5	26	24	17
S10-T402	1/4	1/2	M11×1.0	5.5	29.4	21.5	14	15
S10-T4025	5/16	1/2	1/2-24	7	29.4	22	16	15
S10-T403	3/8	1/2	9/16-24	8	29.4	22.5	17	15
S10-T404	1/2	1/2	11/16-20	11	29.4	25	21	15
S10-T405	5/8	1/2	13/16-18	13	29.5	26	24	17

S11

由任夾壁式接頭 Bulkhead Union

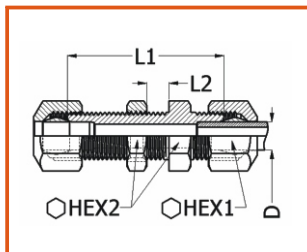

產品編號	適用管徑 D	直牙	L1	L2 最小	L2 最大	HEX1	HEX2
PART NO.	TubeSize D	Thread		L2 min	L2 max		
S11-C06	6	M11×1.0	45	2	19	14	17
S11-C25	8	1/2-24	45	2	19	16	19
S11-C10	10	9/16-24	45	2	19	17	19



產品編號	適用管徑 D	直牙	L1	L2 最小	L2 最大	HEX1	HEX2
PART NO.	TubeSize D	Thread		L2 min	L2 max		
S11-C2	1/4	M11×1.0	45	2	19	14	17
S11-C25	5/16	1/2-24	45	2	19	16	19
S11-C3	3/8	9/16-24	45	2	19	17	19

S12

油塞 Plug

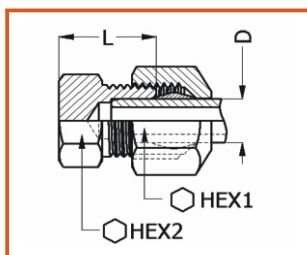

產品編號	適用管徑 D	直牙	L	HEX1	HEX2
PART NO.	TubeSize D	Thread			
S12-C06	6	M11×1.0	13	14	12
S12-C25	8	1/2-24	14	16	14
S12-C10	10	9/16-24	14	17	15



產品編號	適用管徑 D	直牙	L	HEX1	HEX2
PART NO.	TubeSize D	Thread			
S12-C2	1/4	M11×1.0	13	14	12
S12-C25	5/16	1/2-24	14	16	14
S12-C3	3/8	9/16-24	14	17	15

S13

45°外牙彎頭 45° male Elbow

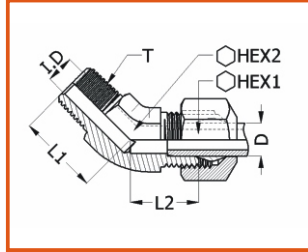

產品編號	適用管徑 D	管牙 T	直牙	I.D	L1	L2	HEX1	HEX2
PART NO.	TubeSize D	Pipe Thread T	Thread					
S13-L1006	6	1/8	M11×1.0	5.5	16	15	14	11
S13-L1010	10	1/8	9/16-24	5.5	16	16	17	14
S13-L2006	6	1/4	M11×1.0	5.5	19	15	14	14
S13-L2010	10	1/4	9/16-24	8	19	16	17	14

產品編號	適用管徑 D	管牙 T	直牙	I.D	L1	L2	HEX1	HEX2
PART NO.	TubeSize D	Pipe Thread T	Thread					
S13-L102	1/4	1/8	M11×1.0	5.5	16	15	14	11
S13-L103	3/8	1/8	9/16-24	5.5	16	16	17	14
S13-L202	1/4	1/4	M11×1.0	5.5	19	15	14	14
S13-L203	3/8	1/4	9/16-24	8	19	16	17	14

- A/E Pipe Fittings
- A/E Hose Barb
- H 45° Flared
- S Compression
- S/B Bite Type
- N Fast-In Fittings
- N/F Ferrule Quick
- P Push-In Fittings
- V Valves